



DIAMOND SYSTEMS CORPORATION

Octavio-HLV System

User Manual



Revision	Date	Comment
v1.00	11/24/09	Initial Release

**FOR TECHNICAL SUPPORT
PLEASE CONTACT:**

support@diamondsystems.com

© Copyright 2009
Diamond Systems Corporation
1255 Terra Bella Ave.
Mountain View, CA 94043 USA
Tel 1-650-810-2500
Fax 1-650-810-2525
www.diamondsystems.com

TABLE OF CONTENTS

1	Introduction	5
1.1	Functional Specifications.....	5
1.2	Physical Specifications.....	6
1.3	Available Options.....	7
2	Functional Overview	8
2.2	Octavio-HLV Functional Block Diagram.....	9
2.3	Helios SBC Functional Block Diagram.....	10
2.4	External Connector Summary.....	11
3	Getting Started	13
3.1	System Setup.....	13
4	External Connectors	15
4.1	Serial Ports 1, 2, 3, 4.....	15
4.2	Serial Ports 5, 6 (optional).....	15
4.3	Keyboard, Mouse.....	16
4.4	USB0, USB1, USB2, USB3.....	17
4.5	Power In.....	17
4.6	VGA.....	18
4.7	Ethernet.....	19
4.8	Digital I/O Port.....	20
4.9	Data Acquisition I/O Connector.....	21
4.10	Expansion I/O (optional).....	22
5	Internal Connectors	23
5.1	SBC Interface Connectors.....	23
5.2	Expansion Board Interface Connectors.....	23
6	Internal Configuration Jumpers	27
6.1	Jumper Summary.....	27
6.2	Data Acquisition Interrupt Configuration (J21).....	27
6.3	RS-232 / RS-422 / RS-485 Configuration (J25, J26).....	28
7	Power Considerations	28
7.1	Power Switch Usage.....	28
7.2	Direct SBC Power vs. Power Via DC/DC Supply Board.....	29
8	Additional Internal Expansion	30
9	End Cap Dimensions	31
10	Technical Support	31

IMPORTANT SAFE HANDLING INFORMATION



WARNING!

- ESD-Sensitive Electronic Equipment
- Observe ESD-safe handling procedures when working with this product.
- Always use this product in a properly grounded work area and wear appropriate ESD-preventive clothing and/or accessories.
- Always store this product in ESD-protective packaging when not in use.

Safe Handling Precautions

The Octavio unit contains a high number of I/O connectors with connection to sensitive electronic components. This creates many opportunities for accidental damage during handling, installation and connection to other equipment. The list here describes common causes of failure found on boards returned to Diamond Systems for repair. This information is provided as a source of advice to help you prevent damaging your Diamond (or any vendor's) embedded computer boards.

ESD damage – This type of damage is usually almost impossible to detect, because there is no visual sign of failure or damage. The symptom is that the board eventually simply stops working, because some component becomes defective. Usually the failure can be identified and the chip can be replaced.

To prevent ESD damage, always follow proper ESD-prevention practices when handling computer boards.

Damage during handling or storage – On some boards we have noticed physical damage from mishandling. A common observation is that a screwdriver slipped while installing the board, causing a gouge in the PCB surface and cutting signal traces or damaging components.

Another common observation is damaged board corners, indicating the board was dropped. This may or may not cause damage to the circuitry, depending on what is near the corner. Most of our boards are designed with at least 25 mils clearance between the board edge and any component pad, and ground / power planes are at least 20 mils from the edge to avoid possible shorting from this type of damage. However these design rules are not sufficient to prevent damage in all situations.

A third cause of failure is when a metal screwdriver tip slips, or a screw drops onto the board while it is powered on, causing a short between a power pin and a signal pin on a component. This can cause overvoltage / power supply problems described below. To avoid this type of failure, only perform assembly operations when the system is powered off.

Power supply wired backwards – Our power supplies and boards are not designed to withstand a reverse power supply connection. This will destroy each IC that is connected to the power supply (i.e. almost all ICs). In this case, the board will most likely cannot be repaired and must be replaced. A chip destroyed by reverse power or by excessive power will often have a visible hole on the top or show some deformation on the top surface due to vaporization inside the package. Check twice before applying power!

Board not installed properly in PC/104 stack – A common error is to install a PC/104 board accidentally shifted by 1 row or 1 column. If the board is installed incorrectly, it is possible for power and ground signals on the bus to make contact with the wrong pins on the board, which can damage the board. For example, this can damage components attached to the data bus, because it puts the $\pm 12V$ power supply lines directly on data bus lines.

Overvoltage on analog input – If a voltage applied to an analog input exceeds the design specification of the board, the input multiplexor and/or parts behind it can be damaged. Most of our boards will withstand an erroneous connection of up to $\pm 35V$ on the analog inputs, even when the board is powered off, but not all boards, and not in all conditions.

Overvoltage on analog output – If an analog output is accidentally connected to another output signal or a power supply voltage, the output can be damaged. On most of our boards, a short circuit to ground on an analog output will not cause trouble.

Overvoltage on digital I/O line – If a digital I/O signal is connected to a voltage above the maximum specified voltage, the digital circuitry can be damaged. On most of our boards the acceptable range of voltages connected to digital I/O signals is 0-5V, and they can withstand about 0.5V beyond that (-0.5 to 5.5V) before being damaged. However logic signals at 12V and even 24V are common, and if one of these is connected to a 5V logic chip, the chip will be damaged, and the damage could even extend past that chip to others in the circuit.

Bent connector pins – This type of problem is often only a cosmetic issue and is easily fixed by bending the pins back to their proper shape one at a time with needle-nose pliers. The most common cause of bent connector pins is when a PC/104 board is pulled off the stack by rocking it back and forth left to right, from one end of the connector to the other. As the board is rocked back and forth it pulls out suddenly, and the pins at the end get bent significantly. The same situation can occur when pulling a ribbon cable off of a pin header. If the pins are bent too severely, bending them back can cause them to weaken unacceptably or even break, and the connector must be replaced.

1 INTRODUCTION

Octavio-HLV embedded application servers are compact, rugged systems aimed at a wide variety of data acquisition and control applications. The systems are based Diamond's field-proven Helios PC/104 single board computer, which combines an 800MHz Vortex86DX CPU and integrated peripheral interface functions along with Diamond's industry-leading high-accuracy data acquisition circuitry.

Octavio-HLV comes with 256MB of soldered DRAM for increased resistance to shock and vibration. It also has a 128MB or 1GB solid state IDE flashdisk pre-loaded with Linux 2.6.23 and Diamond's Universal Driver data acquisition programming software, leaving ample room for your application on the flashdisk.

Standard system I/O includes VGA graphics, a 10/100Base-T Ethernet interface, four USB 2.0 ports, two RS-232 serial ports, two RS-232/422/485 ports, and PS/2 keyboard and mouse interfaces.

When ordered with its optional data acquisition (DAQ) subsystem, Octavio-HLV provides 16 16-bit A/D inputs with 100KHz sample rate, 4 12-bit D/A outputs, 40 digital I/O lines, and 2 counter/timers. Multi-range autocalibration on both A/D and D/A ensures maximum accuracy over time and temperature.

The Octavio-HLV enclosure is designed to eliminate most internal cables, resulting in enhanced ruggedness and reliability in both fixed and mobile environments.

All of the system's standard interfaces are accessible on the front of the enclosure via industry standard connectors, which are mounted on a Panel I/O Board. The Panel I/O Board also accommodates I/O from selected PC/104 add-on modules. The system is highly shock and vibration tolerant, and can operate fanless over -40°C to +85°C.

1.1 Functional Specifications

1.1.1 System Core Functions

- Based on Diamond Systems Helios single-board computer (SBC)
 - Processor: 800MHz Vortex86DX CPU
 - System Memory: 256MB soldered DRAM
- Display type: VGA CRT; up to 1280 x 1024 resolution
- USB ports: four USB 2.0
- Serial ports
 - Standard: two RS-232/422/485; two RS-232-only
 - Option: additional two RS-232/422/485 (requires 3-inch or taller system height)
- Networking: 10/100Base-T Ethernet
- 16 digital I/O lines
- Mass storage: integrated 128MB or 1GB IDE flashdisk
- Keyboard/mouse: PS/2 or USB
- Operating system: Linux 2.6.23
- System software: Universal Driver 6.02

1.1.2 Data Acquisition Subsystem (on select models)

- Analog Inputs
 - Inputs: 16 single-ended or 8 differential, user selectable
 - 16 bits A/D resolution: 16 bits
 - Input ranges: $\pm 10V$, $\pm 5V$, $\pm 2.5V$, $\pm 1.25V$, 0 - 10V, :0 - 5V, 0 - 2.5V programmable
 - Max sample rate 100KHz
 - Protection: $\pm 35V$ on any analog input without damage
 - Nonlinearity: $\pm 3LSB$, no missing codes
 - Onboard FIFO

- 2048 samples, programmable threshold
- A/D and D/A calibration
- Autocalibration with software support
- Analog Outputs
 - Number of outputs: 4, 12-bit resolution
 - Output ranges: $\pm 5V$, $\pm 10V$, 0-5V, 0-10V
 - Output current: $\pm 5mA$ max per channel
 - Settling time: 10 μ S max to 0.012%
 - Relative accuracy: ± 2 LSB
 - Nonlinearity: ± 2 LSB, monotonic
- Digital I/O
 - Number of I/O lines: 40 lines
 - Input voltage: Logic 0: 0.5V min, 0.8V max; Logic 1: 2.0V min, 5.5V max
 - Input current: $\pm 3\mu A$ max
 - Output voltage: Logic 0: 0.0V min, 0.4V max; Logic 1: 2.4V min, 3.3V max
 - Output current: Logic 0: 12mA max per line; Logic 1: 8mA max per line
- Counter/Timers
 - A/D pacer clock 24-bit down counter
 - Clock source: 10MHz onboard clock or external signal
 - General purpose 16-bit down counter

1.2 Physical Specifications

1.2.1 Power

- Input power
 - Standard: 5VDC $\pm 5\%$
 - Optional: 7-30VDC variable-input power supply module
- Power Consumption: 5W typical (assumes minimally-configured base model)

1.2.2 Mechanical

- Footprint: 5.75 x 5.50 inches (145 x 138mm)
- Four case heights: 1.7, 3.0, 5.0, 7.0 inches (43, 76, 127, 178 mm)
- Weight: 31 oz (864 g), for minimally-configured 1.7-inch height model

1.2.3 Environmental

- FCC Class B: available on request
- UL: CUL available on request
- CE Mark: available on request
- RoHS: compliant

1.2.4 Thermal

- Operating temperature: -40 to +85°C
- Storage temperature: -40 to +85°C

Note: These values pertain to standard Octavio-HLV models only. The system's operating temperature range will be limited by the thermal characteristics of any modules added to the system.

1.3 Available Options

Octavio-HLV systems come in standard, default configurations for various system aspects such as serial port and data acquisition functions. Some of these may be configured to your specifications during manufacturing. The table below indicates the options that are available as standard product. For further details on how to order an Octavio-HLV system with a selection of these options, please refer to the [Octavio Ordering Guide](#), available for download from the Diamond Systems website.

<i>Option</i>	<i>Description</i>
Helios SBC model	Based on 800MHz Vortex86DX CPU; includes onboard data acquisition subsystem Based on 800MHz Vortex86DX CPU; without onboard data acquisition subsystem
Flashdisk	128MB flashdisk, pre-loaded with Linux 2.6.23 1GB flashdisk, pre-loaded with Linux 2.6.23 (All flashdisks come with a Linux 2.6.23 bootable image and Diamond's Universal Driver 6.02 software pre-loaded.)
Case height	1.7 inches – enables addition of a notebook hard drive 3.0 inches – enables addition of up to 2 add-on PC/104 boards and a notebook hard drive 5.0 inches – enables addition of up to 5 add-on PC/104 boards and a notebook hard drive 7.0 inches – enables addition of up to 7 add-on PC/104 boards and a notebook hard drive
DIN Rail Adapter	No DIN rail adapter kit With DIN rail adapter kit
Variable-input Power Supply	none (default) 25 watt DC/DC power supply (requires 3-inch or greater case height) 50 watt DC/DC power supply (requires 3-inch or greater case height)
Serial Ports 1 and 2 data protocol	RS-232 (default) RS-422 RS-485
Data Acquisition Interrupt	Enabled (default) Disabled
Data Acquisition Interrupt IRQ	IRQ5 (default) IRQ6
Console Redirection	Off (default) On

1.3.1 Additional Customization

Additional customizations can be accommodated. Following are some examples:

- Add an integrated 80GB hard disk drive
- Integrate Diamond's PC/104 I/O modules (height of enclosure may change)
- Substitute Windows CE for Linux operating system

Contact Diamond Systems for details on these and other customization options.

2 FUNCTIONAL OVERVIEW

The key physical components of a minimally-configured Octavio-HLV system are illustrated in the figure below. Taller Octavio-HLV models can accommodate one or more PC/104 add-on modules, which stack on the PC/104 expansion bus located on the bottom of the Helios single board computer (SBC).

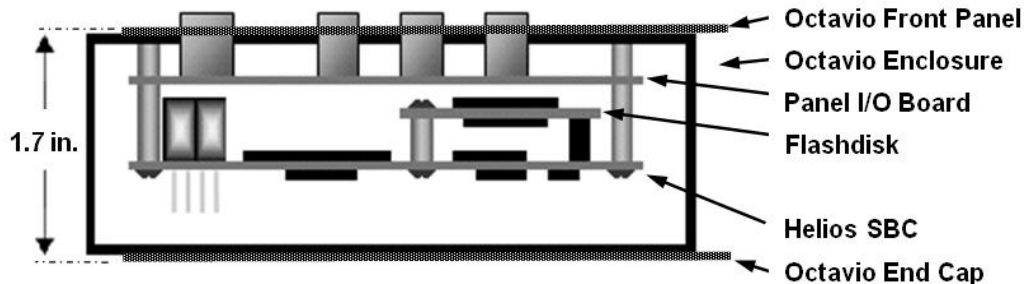

2.1.1 Helios SBC

The Helios single board computer (SBC) implements Octavio-HLV's core embedded computing and system interface functions. The SBC provides stackthrough PC/104 bus pins on its underside; these accommodate the addition of add-on modules in Octavio models taller than the 1.7-inch high base model.

2.1.2 Panel I/O Board

Nearly all of the I/O interface signals present on Octavio-HLV's external interface connectors originate from functions on the Helios SBC. The Panel I/O Board serves as a transition adapter between male header connectors on the top of the Helios SBC and industry-standard interface connectors accessible from the top of the Octavio-HLV.

The Panel I/O Board also provides a several external interface connectors that carry I/O signals that are associated with optional PC/104 add-on modules, which are installed below the SBC inside the Octavio-HLV. This modular expansion is only possible in systems having case heights of 3-inches or greater.

2.1.3 DC Power Input

The Power Control circuitry on the Panel I/O Board supports two sources of DC power input:

- A +5VDC $\pm 5\%$
- A 7-30VDC variable input source

Octavio comes pre-configured for one or the other of these options, depending on whether it includes an optional variable-input DC/DC converter power supply module. Technical details regarding the reconfiguration of this feature are described in the section *Power Considerations* on page 28.

2.2 Octavio-HLV Functional Block Diagram

The block diagram below illustrates the functional subsystems contained within the minimally-configured Octavio-HLV system. These subsystems are briefly described thereafter.

Octavio-HLV Functional Block Diagram

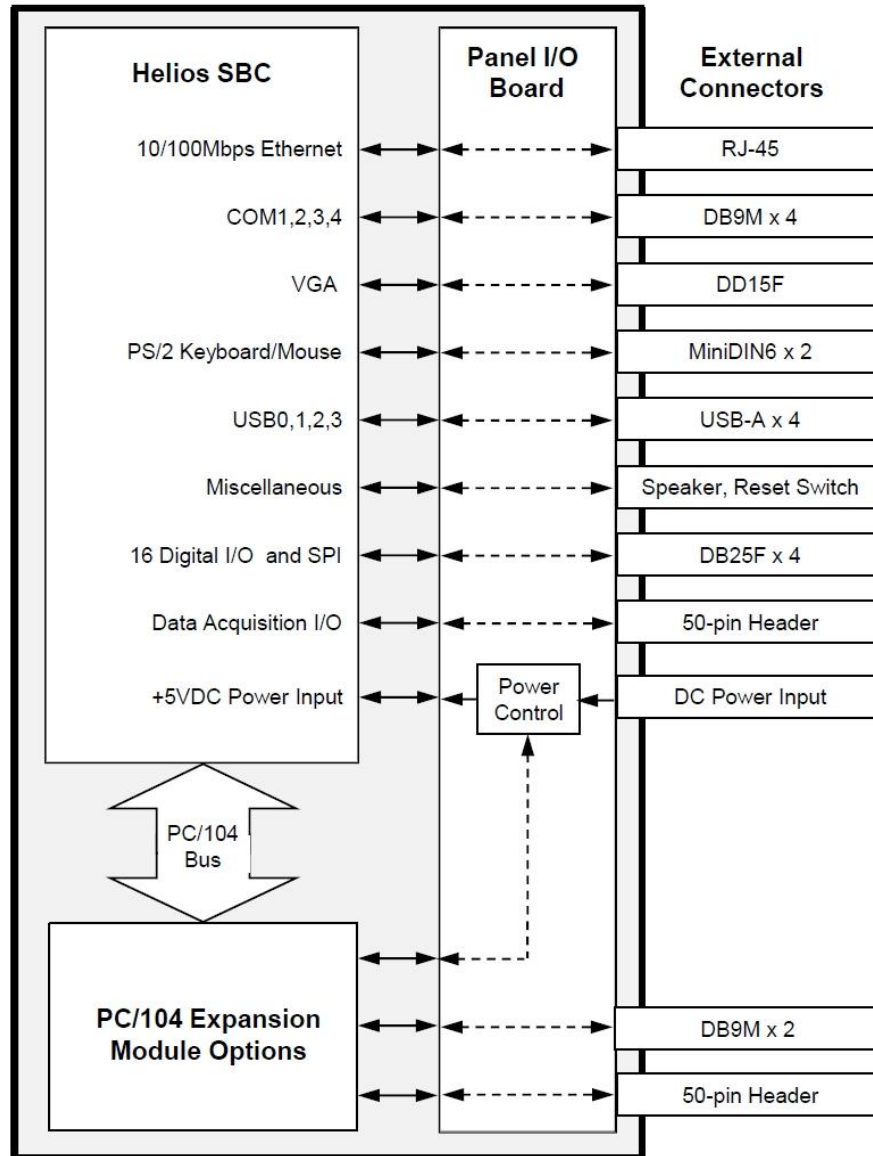

2.3 Helios SBC Functional Block Diagram

The Helios SBC's block diagram appears below.

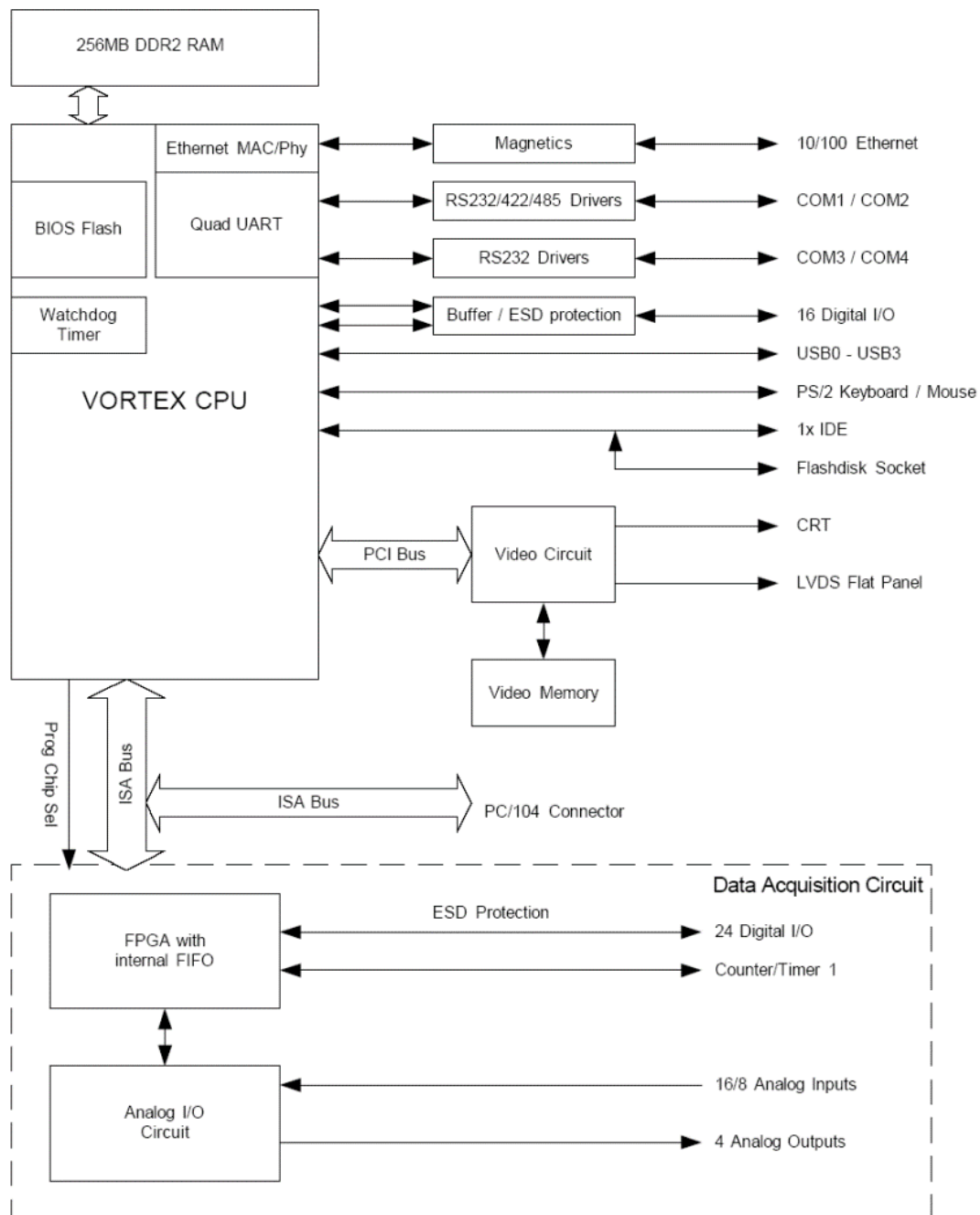

For more information about the Helios SBC, refer to the [Helios User Manual](#) (PDF file link), which can be downloaded from the Diamond Systems website's [Helios page](http://www.diamondsystems.com/helios) (<http://www.diamondsystems.com/helios>).

2.4 External Connector Summary

The figure below illustrates Octavio's front panel I/O interface connectors. These connectors, which are mounted on the top side of the Panel I/O Board, provide basic computer functions such as keyboard, mouse, VGA, Ethernet, and USB. In addition, there are connectors for use with user-defined serial, analog, and digital I/O add-on modules. The table on the following page summarizes the utilization of each connector. For details regarding the functions and signal assignment of each external connector, refer to Section 4 of this document.

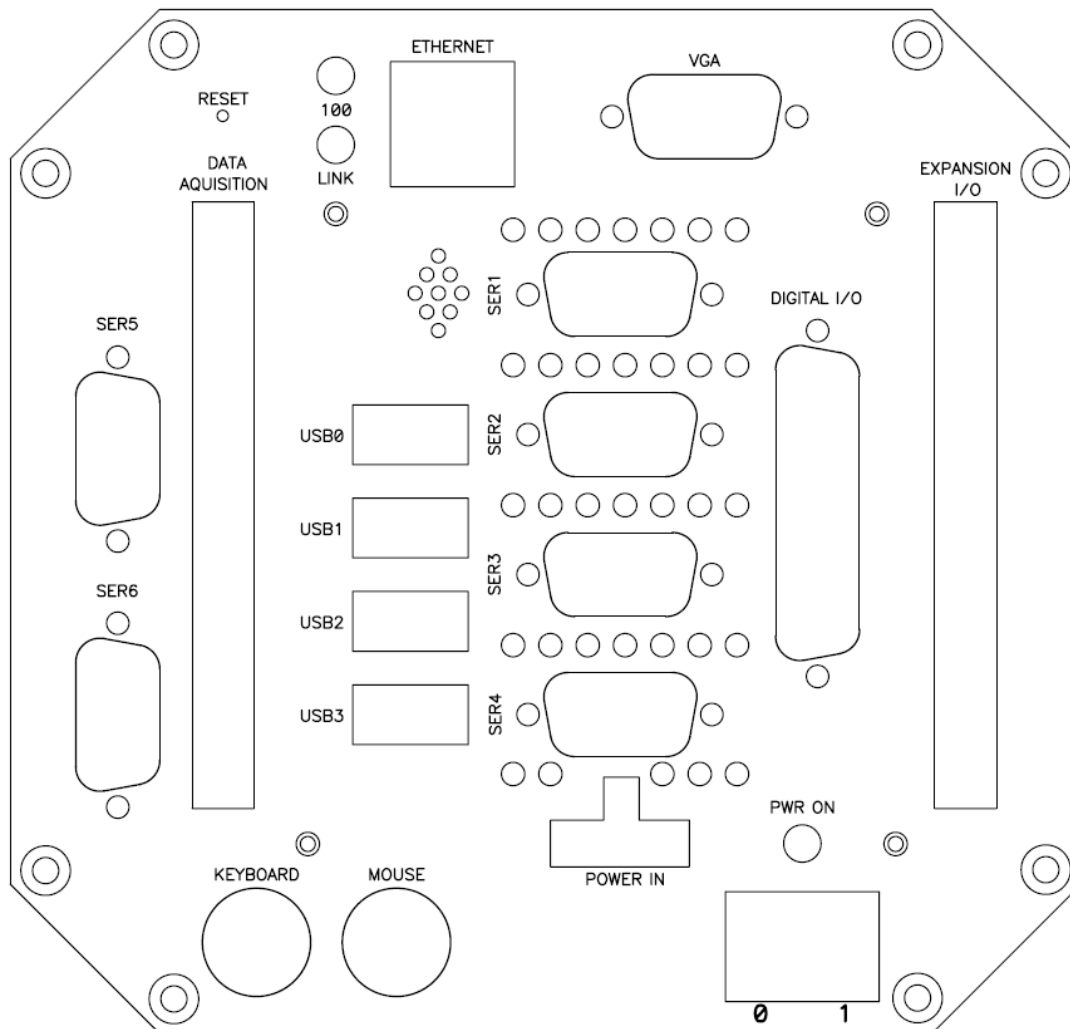

<i>Label on Enclosure</i>	<i>Connector Type</i>	<i>Function</i>
SER1, SER2	DB9 male	Serial port. Default RS-232, can be configured as RS-232, RS-422, or RS-485.
SER3, SER4	DB9 male	Serial port. RS-232 only.
SER5, SER6	DB9 male	Serial port, available with expansion serial I/O card (otherwise not connected). Default RS-232, can be configured as RS-232, RS-422, or RS-485.
USB0-USB3	USB Type A	Universal Serial Bus
ETHERNET	RJ45	Ethernet port
VGA	DD15 female	Video port
KEYBOARD	Mini-DIN female	Interface to PS/2 keyboard
MOUSE	Mini-DIN female	Interface to PS/2 mouse
DIGITAL I/O	DB25 male	16 digital I/O signals from the SBC
DATA ACQUISITION	50-pin locking male header	Data acquisition signals from the SBC
EXPANSION I/O	50-pin locking male header	Optional interface to up to 2 PC/104 modules installed below the SBC inside the enclosure
POWER INPUT	Molex 39-30-2045 or equivalent	Input power. +5VDC default; optionally configurable for variable input voltage.

3 GETTING STARTED

The Octavio-HLV is shipped fully assembled. Following are instructions to start using the Octavio-HLV system.

WARNING!

Be sure to observe the ESD precautions listed on page 3 of this manual.

3.1 System Setup

3.1.1 Display

Octavio-HLV can be used with standard VGA-interfaced CRT or LCD monitors. Plug the monitor's VGA interface cable into the system's external VGA connector.

3.1.2 Keyboard and Mouse

Octavio-HLV supports operation using either PS/2- or USB-interfaced keyboard and mouse devices, in any combination. Connect these peripheral devices as follows:

- Connect the cable from a PS/2 keyboard to the external connector labeled KEYBOARD
- Connect the cable from a PS/2 mouse to the external connector labeled MOUSE
- Connect the cables from a USB keyboard or USB mouse to any of the system's USB ports (USB0, USB1, USB2, or USB3)

3.1.3 Input Power

Connect an external source of +5V \pm 5% DC power to pin 4 of the POWER IN connector, and GROUND to either (or both) pins 2 or 3. Refer to the figure below for the connector's pin numbering.

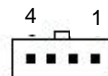

Alternatively, if your Octavio-HLV was shipped with the optional variable-voltage DC/DC power supply, you can connect an external source of 7-30V DC to pin 1 of the POWER IN connector, and GROUND to either (or both) of pins 2 or 3.

3.1.4 System Boot

Turn on the DC power supply. The unit will display startup messages, and then boot to a Linux prompt.

3.1.5 Linux Operating system

Octavio-HLV contains an IDE flashdisk attached to the Helios SBC. This solid-state disk device by default contains a bootable Linux OS, which provides a quick-boot compact Linux environment based on combination of Slackware 2.6.23 kernel with BusyBox tools. The Linux OS utilizes the EXT3 file system, and grub bootloader for a quick boot.

For more information regarding Octavio-HLV's embedded Linux operating system, refer to the [Linux SDK description](#) on the Diamond Systems website.

3.1.6 Data Acquisition Operation

Note: This function depends on the model of Octavio-HLV.

The Linux system image installed on the flashdisk also contains software demonstration programs for the Helios-SBC's optional data acquisition subsystem. You may access the directory of these programs by typing:

```
>cd /home/helios
```

In this directory reside the source code, makefile and executables of the demonstration programs. Each demonstration program executable and source code is contained in its own directory. A good first demonstration program to run is the DSCADAutoCal program.

The DSCADAutoCal program will calibrate the A/D data acquisition circuitry to guarantee accurate A/D input readings. To run the program type the following while in the demonstration programs directory:

```
> ./DSCADAutoCal/DSCADAutoCal
```

The program will ask the user to input the following values:

- Base address: This is the base address of the board determined by jumper settings JP2. For demonstration purposes type 0x280.
- Range to calibrate: This is the A/D modes users would typically calibrate. The modes are 0-7. For demonstration purposes type 255 which will calibrate all the modes.
- Range to boot: This is the A/D mode users typically boot up the board in. The modes are 0-1, 4-6. For demonstration purposes type 255 which will calibrate all the modes.

Once initiated the program will calibrate the mode the user specified. The process may take up to 15 seconds, after which the error values will be printed on screen for each mode; values less than +-2 are within tolerance.

For more details regarding A/D modes, refer to section "Input Ranges and Resolutions" in the Helios User's Manual.

For more information regarding the software API and functions, refer to the Universal Driver Software manual at http://docs.diamondsystems.com/dscud/manual_Main+Page.html.

3.1.7 Console Redirection Option

Octavio-HLV provides the ability to utilize a serially-interfaced computer other device as the system console, instead of (or in addition to) using the normal VGA CRT display and PS/2 or USB keyboard. Octavio-HLV by default comes with serial console redirection turned off. If desired, the system can be ordered with console redirection activated.

When console redirection is activated, Octavio-HLV's SER1 serial port provides a remote serial console interface preconfigured for 19200 bps (any valid baud rate supported by the BIOS can be used up to 115200). Additionally, the VGA CRT port and PS/2 or USB keyboard functions remain operational.

To use the systems serial console function (assuming it is activated) configure the remote device as follows:

- Data rate: 19200 bps
- Data bits: 8
- Parity: none
- Stop bits: 1
- Flow control: None

In systems without serial console redirection activated at the factory, it is possible to install this capability by performing several configuration steps. Contact Diamond Systems Technical Support for details.

4 EXTERNAL CONNECTORS

This section describes Octavio's external interface connectors. These are intended for direct connection via standard external peripheral interface cables for devices such as a PS/2 keyboard and mouse, VGA monitor, and various serial devices. The external connectors discussed in this section are affixed to the top side of the Panel I/O Board. These connectors' signals come from another set of connectors located on the bottom side of the Panel I/O Connector. The latter set of connectors is discussed in detail in the next section, "Internal Connectors."

4.1 Serial Ports 1, 2, 3, 4

These four serial port connectors, labeled on the outside of the enclosure as SER1, SER2, SER3 and SER4, are male DB9 connectors. They connect via the Panel I/O Board to the Helios SBC.

Depending on the preassembled setup of the Octavio-HLV systems, serial ports can be either standard or configured at the time of order.

- In a standard Octavio-HLV system, SER1-4 only support RS-232 protocols.
- The Octavio-HLV can be ordered with SER1 and SER2 configured to support RS-422, or RS-485 protocols. (SER3 and SER4 are limited to RS-232 only.)



RS-232 Configuration

<i>Signal Name</i>	<i>DB9 Pin</i>	<i>Signal Name</i>
DCD 1	1 6	DSR 1
RXD 1	2 7	RTS 1
TXD 1	3 8	CTS 1
DTR 1	4 9	RI 1
GND	5	

RS-422 Configuration

<i>Signal Name</i>	<i>DB9 Pin</i>	<i>Signal Name</i>
NC	1 6	NC
TXD+ 1	2 7	TXD- 1
GND	3 8	RXD- 1
RXD+ 1	4 9	NC
GND	5	

RS-485 Configuration

<i>Signal Name</i>	<i>DB9 Pin</i>	<i>Signal Name</i>
NC	1 6	NC
TXD/RXD + 1	2 7	TXD/RXD - 1
GND	3 8	NC
NC	4 9	NC
GND	5	

4.2 Serial Ports 5, 6 (optional)

Two DB9 serial port connectors, labeled SER5 and SER6 on the outside of the enclosure, are available for use with an internal add-on serial I/O expansion card. The following considerations apply:

- This feature is not included in the standard Octavio-HLV system.
- The signals for these ports must be provided via a serial I/O expansion card plugged into the PC/104 bus below the Helios SBC (for example, Diamond's Emerald-MM expansion module). The connection requires an internal cable between the expansion card and a connector on the bottom of the Panel I/O Board (see Section 5 for details).
- When a Diamond Emerald-MM expansion card is utilized, these connectors can be configured to support RS-232, RS-422, or RS-485 protocols.

The signals provided by the external serial port connectors for SER5 and SER6 are numbered (viewed from the outside) and have the functions indicated below. The signal functions on each of these ports depend on the serial protocol configured on the associated PC/104 add-in card, as indicated below.

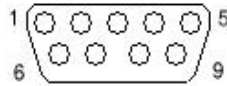

RS-232 Configuration (all four ports)

Signal Name	DB9 Pin	Signal Name
DCD 1	1 6	DSR 1
RXD 1	2 7	RTS 1
TXD 1	3 8	CTS 1
DTR 1	4 9	RI 1
GND	5	

RS-422 Configuration (option for SER1 and SER2)

Signal Name	DB9 Pin	Signal Name
NC	1 6	NC
TXD+ 1	2 7	TXD- 1
GND	3 8	RXD- 1
RXD+ 1	4 9	NC
GND	5	

RS-485 Configuration (option for SER1 and SER2)

Signal Name	DB9 Pin	Signal Name
NC	1 6	NC
TXD/RXD + 1	2 7	TXD/RXD - 1
GND	3 8	NC
NC	4 9	NC
GND	5	

4.3 Keyboard, Mouse

These two 6-pin female Mini-DIN connectors provide interfaces for USB Keyboard and Mouse devices. The signals connect via the Panel I/O Board to the Helios SBC.

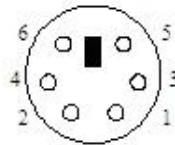

KEYBOARD/MOUSE — Mini-DIN Connector

1	Data
2	Reserved
3	System Ground
4	System Power (5V)
5	Data Clock
6	Reserved

4.4 USB0, USB1, USB2, USB3

These four connectors are industry standard Type A USB connectors. The signals connect via the Panel I/O Board to the Helios SBC.

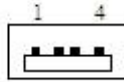

USB1, USB2, USB3, USB4 -- Type A USB connector

1	System Power (5V)
2	Data Positive
3	Data Negative
4	System Ground

4.5 Power In

Input power may be supplied either as +5VDC or as Vin.

- The +5V is switched directly to the PC/104 bus power pins via the external power switch.
- The Vin is switched to an auxiliary connector on the back side of the board which is used to connect to a DC/DC power supply.

The output of the DC/DC power supply is then fed either to the PC/104 bus power pins (if the power supply is on the PC/104 bus) or back to the Panel I/O Board and then to the SBC through the +5V pins on the SBC mating power input connector.



POWER IN — Power Input Connector

1	Vin
2	System Ground
3	System Ground
4	+5V In

4.6 VGA

The VGA connector is a traditional, industry standard female DB15 connector, which is numbered (viewed from the outside) as shown below:

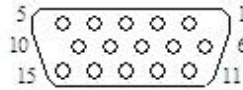

1	Red Video
2	Green Video
3	Blue Video
4	Reserved
5	System Ground
6	System Ground
7	System Ground
8	System Ground
9	Reserved
10	System Ground
11	Reserved
12	Identification Serial Data
13	Horizontal Sync
14	Vertical Sync
15	Identification Serial Clock

4.7 Ethernet

The Ethernet connector is a standard RJ45 Ethernet connector wired to support 10/100BaseT Ethernet.

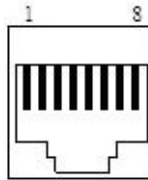

ETHERNET — RJ45 Ethernet Connector

1	Tx Positive
2	Tx Negative
3	Rx Positive
4	System Ground
5	System Ground
6	RX Negative
7	System Ground
8	System Ground

4.8 Digital I/O Port

The digital I/O connector is a vertical DB25 male connector that connects via the Panel I/O Board to the Helios SBC's mating digital I/O connector.

Note: *Despite being implemented in the form of DB25 male connector, this connector's pinout follows the convention for DB25 female connectors.*

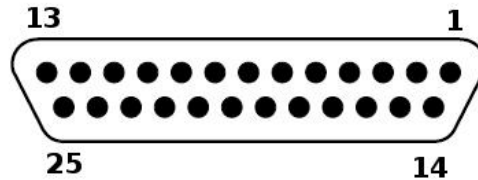

Digital I/O Port

Signal Name	DB25 Pin		Signal Name
DIO LCA0	1	14	DIO LCA1
DIO LCA2	2	15	DIO LCA3
DIO LCA4	3	16	DIO LCA5
DIO LCA6	4	17	DIO LCA7
DIO LCB0	5	18	DIO LCB1
DIO LCB2	6	19	DIO LCB3
DIO LCB4	7	20	DIO LCB5
DIO LCB6	8	21	DIO LCB7
+5V	9	22	GND
NC	10	23	GND
NC	11	24	NC
NC	12	25	NC
NC	13		

4.9 Data Acquisition I/O Connector

The Data Acquisition I/O connector is a 50-pin locking header connector that connects via the Panel I/O Board to the Helios SBC's mating Data Acquisition I/O connector. This function is only available in Octavio-HLV models that include the Helios SBC with data acquisition subsystem.

I/O 2 — Data I/O Port 2 Connector

I/O Port Pin 1	1	26	I/O Port Pin 26
I/O Port Pin 2	2	27	I/O Port Pin 27
I/O Port Pin 3	3	28	I/O Port Pin 28
I/O Port Pin 4	4	29	I/O Port Pin 29
I/O Port Pin 5	5	30	I/O Port Pin 30
I/O Port Pin 6	6	31	I/O Port Pin 31
I/O Port Pin 7	7	32	I/O Port Pin 32
I/O Port Pin 8	8	33	I/O Port Pin 33
I/O Port Pin 9	9	34	I/O Port Pin 34
I/O Port Pin 10	10	35	I/O Port Pin 35
I/O Port Pin 11	11	36	I/O Port Pin 36
I/O Port Pin 12	12	37	I/O Port Pin 37
I/O Port Pin 13	13	38	I/O Port Pin 38
I/O Port Pin 14	14	39	I/O Port Pin 39
I/O Port Pin 15	15	40	I/O Port Pin 40
I/O Port Pin 16	16	41	I/O Port Pin 41
I/O Port Pin 17	17	42	I/O Port Pin 42
I/O Port Pin 18	18	43	I/O Port Pin 43
I/O Port Pin 19	19	44	I/O Port Pin 44
I/O Port Pin 20	20	45	I/O Port Pin 45
I/O Port Pin 21	21	46	I/O Port Pin 46
I/O Port Pin 22	22	47	I/O Port Pin 47
I/O Port Pin 23	23	48	I/O Port Pin 48
I/O Port Pin 24	24	49	I/O Port Pin 49
I/O Port Pin 25	25	50	I/O Port Pin 50

4.10 Expansion I/O (optional)

The external expansion I/O connector is a 50-pin locking header connector. The signals come from the general purpose expansion I/O connector on the bottom side of the Panel I/O Board and have a 1-to-1 correspondence with that connector's pinout.

Note: These signals do not come from the Helios SBC. They must be supported by other internal boards on the Helios SBC's PC/104 expansion bus, using a cable from the expansion board to the bottom of the Panel I/O Board.

I/O Port Pin 1	1	26	I/O Port Pin 26
I/O Port Pin 2	2	27	I/O Port Pin 27
I/O Port Pin 3	3	28	I/O Port Pin 28
I/O Port Pin 4	4	29	I/O Port Pin 29
I/O Port Pin 5	5	30	I/O Port Pin 30
I/O Port Pin 6	6	31	I/O Port Pin 31
I/O Port Pin 7	7	32	I/O Port Pin 32
I/O Port Pin 8	8	33	I/O Port Pin 33
I/O Port Pin 9	9	34	I/O Port Pin 34
I/O Port Pin 10	10	35	I/O Port Pin 35
I/O Port Pin 11	11	36	I/O Port Pin 36
I/O Port Pin 12	12	37	I/O Port Pin 37
I/O Port Pin 13	13	38	I/O Port Pin 38
I/O Port Pin 14	14	39	I/O Port Pin 39
I/O Port Pin 15	15	40	I/O Port Pin 40
I/O Port Pin 16	16	41	I/O Port Pin 41
I/O Port Pin 17	17	42	I/O Port Pin 42
I/O Port Pin 18	18	43	I/O Port Pin 43
I/O Port Pin 19	19	44	I/O Port Pin 44
I/O Port Pin 20	20	45	I/O Port Pin 45
I/O Port Pin 21	21	46	I/O Port Pin 46
I/O Port Pin 22	22	47	I/O Port Pin 47
I/O Port Pin 23	23	48	I/O Port Pin 48
I/O Port Pin 24	24	49	I/O Port Pin 49
I/O Port Pin 25	25	50	I/O Port Pin 50

5 INTERNAL CONNECTORS

This section provides reference information regarding the connectors used to interface between the Panel I/O Board, the Helios SBC, and certain expansion cards in the PC/104 stack.

5.1 SBC Interface Connectors

The table below lists the connectors on the bottom of the Panel I/O Board that interface with the system's Helios SBC. These connectors plug directly into the top of the Helios SBC, so their signal definitions are identical to those of the mating connectors on the SBC.

For further details regarding the function and signal assignment of each of the connectors listed below, refer to the [Helios User Manual](#) (PDF file link), which can be downloaded from the Diamond Systems website's [Helios page](#).

<i>SBC Interface Connector Function</i>	<i>Label</i>	<i>Connector Type</i>
PS/2 keyboard/mouse	J10	2x5 female header
VGA	J12	2x5 female header
Ethernet	J13	2x5 female header
Miscellaneous (speaker out, power LED, reset)	J14	2x5 female header
USB0, USB1	J15	2x5 female header
USB2, USB3	J16	2x5 female header
Data Acquisition	J17	2x25 female header
Digital I/O	J18	2x10 female header
SER1, SER2, SER3, SER4	J19	2x20 female header
Power	J29	2x4 female header

5.2 Expansion Board Interface Connectors

This section provides reference information regarding connectors on the bottom of the Panel I/O Board that are used with signals from optional expansion cards plugged via PC/104 into the bottom of the Helios SBC. Each of these connectors, summarized in the table below, corresponds to an external interface connector located on the top of the Panel I/O Board.

<i>Expansion Interface Connector Function</i>	<i>Label</i>	<i>Connector Type</i>
Expansion I/O	J31	2x25 male header
Expansion Serial	J32	2x20 male header
Power Interface to DC/DC power expansion board	J33	1x6 male header

5.2.1 Expansion I/O (J31)

The connector at J31 is designed to provide an interface to the outside from a 50-pin connector on an expansion board in the PC/104 stack. This connector is a 2x25 pin, 0.1-inch pitch male header that connects pin for pin with Octavio-HLV's external "EXPANSION I/O" connector.

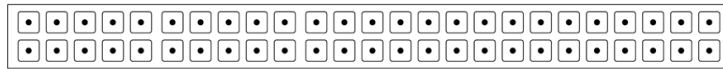

Pin 1

J31 — Data Acquisition to Expansion Board

I/O Pin 1	1	2	I/O Pin 26
I/O Pin 2	3	4	I/O Pin 27
I/O Pin 3	5	6	I/O Pin 28
I/O Pin 4	7	8	I/O Pin 29
I/O Pin 5	9	10	I/O Pin 30
I/O Pin 6	11	12	I/O Pin 31
I/O Pin 7	13	14	I/O Pin 32
I/O Pin 8	15	16	I/O Pin 33
I/O Pin 9	17	18	I/O Pin 34
I/O Pin 10	19	20	I/O Pin 35
I/O Pin 11	21	22	I/O Pin 36
I/O Pin 12	23	24	I/O Pin 37
I/O Pin 13	25	26	I/O Pin 38
I/O Pin 14	27	28	I/O Pin 39
I/O Pin 15	29	30	I/O Pin 40
I/O Pin 16	31	32	I/O Pin 41
I/O Pin 17	33	34	I/O Pin 42
I/O Pin 18	35	36	I/O Pin 43
I/O Pin 19	37	38	I/O Pin 44
I/O Pin 20	39	40	I/O Pin 45
I/O Pin 21	41	42	I/O Pin 46
I/O Pin 22	43	44	I/O Pin 47
I/O Pin 23	45	46	I/O Pin 48
I/O Pin 24	47	48	I/O Pin 49
I/O Pin 25	49	50	I/O Pin 50

5.2.2 Expansion Serial (J32)

Connector J32 provides an interface to a serial port expansion board such as the Diamond Systems Emerald-MM. The connector is a 2x10 pin, 0.1-inch pitch male header designed to interface via a cable to the connectors on the Emerald-MM. The figure below shows the pinout of J32 on the bottom of the Panel I/O Board.



Pin 1

When used with the Diamond Emerald-MM serial expansion module, J32 has the signal definitions illustrated in the three tables below, depending on the selected serial protocol (RS-232, RS-422, or RS-425).

RS-232 Configuration

DCD 1	1	2	DSR 1
RXD 1	3	4	RTS 1
TXD 1	5	6	CTS 1
DTR 1	7	8	RI 1
GND	9	10	NC
DCD 2	11	12	DSR 2
RXD 2	13	14	RTS 2
TXD 2	15	16	CTS 2
DTR 2	17	18	RI 2
GND	19	20	NC

RS-422 Configuration

NC	1	2	NC
TXD+ 1	3	4	TXD- 1
GND	5	6	RXD- 1
RXD+ 1	7	8	NC
GND	9	10	NC
NC	11	12	NC
TXD+ 2	13	14	TXD- 2
GND	15	16	RXD- 2
RXD+ 2	17	18	NC
GND	19	20	NC

RS-485 Configuration

NC	1	2	NC
TXD/RXD+ 1	3	4	TXD/RXD- 1
GND	5	6	NC
NC	7	8	NC
GND	9	10	NC
NC	11	12	NC
TXD/RXD+ 2	13	14	TXD/RXD- 2
GND	15	16	NC
NC	17	18	NC
GND	19	20	NC

5.2.4 DC/DC Power Supply Interface (J33)

Connector J33, a 6-pin single-in-line header, is used for interconnecting the front panel power input to an optional variable-input DC/DC power supply board, such as Diamond’s Jupiter-MM, located in the PC/104 stack.

When this interface is used, the direct SBC power interface through connector J29 is not used. Instead, the Helios SBC and other modules on the PC/104 bus stacked below it are powered through the PC/104 bus by the power supply board. Connector J33 is cabled to the DC/DC power supply board as indicated in the cabling drawing, below.

J33 —DC/DC Power Supply Interface

1	External power to DC/DC converter board
2	Ground
3	Ground
4	+5VDC from DC/DC converter board
5	+5VDC from DC/DC converter board
6	+12VDC from DC/DC converter board

Further information regarding the optional internal DC/DC power supply are available in Section 7, “Power Considerations.”

6 INTERNAL CONFIGURATION JUMPERS

This section provides information regarding the setting of jumper options on the Octavio-HLV system's internal Helios SBC. For further details regarding the function of the various configuration jumpers, refer to the [Helios User Manual](#) (PDF file link), which can be downloaded from the Diamond Systems website's [Helios page](#).

Note: The availability of configuration options is related to the model of Octavio-HLV. The following information applies to the standard, minimally-configured Octavio-HLV.

6.1 Jumper Summary

<i>Jumper</i>	<i>Location</i>	<i>Description</i>
J21	Helios SBC	DAQ interrupt configuration
J25	Helios SBC	SER1 RS-422/RS-485 configuration
J26	Helios SBC	SER2 RS-422/RS-485 configuration

6.2 Data Acquisition Interrupt Configuration (J21)

IRQ5 with pulldown is the default setting for Data Acquisition (DAQ) interrupt. On Helios SBCs without the data acquisition function, J21 is removed.

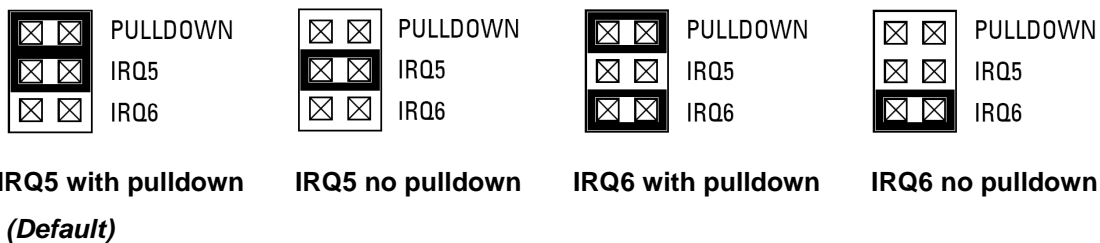

<i>Label</i>	<i>Function</i>
PULLDOWN	Enables 1K Ω pull-down resistor for the data acquisition IRQ selected
IRQ5	Selects IRQ5 for the data acquisition circuit
IRQ6	Selects IRQ6 for the data acquisition circuit

6.3 RS-232 / RS-422 / RS-485 Configuration (J25, J26)

RS-232 is the default setting for serial ports.

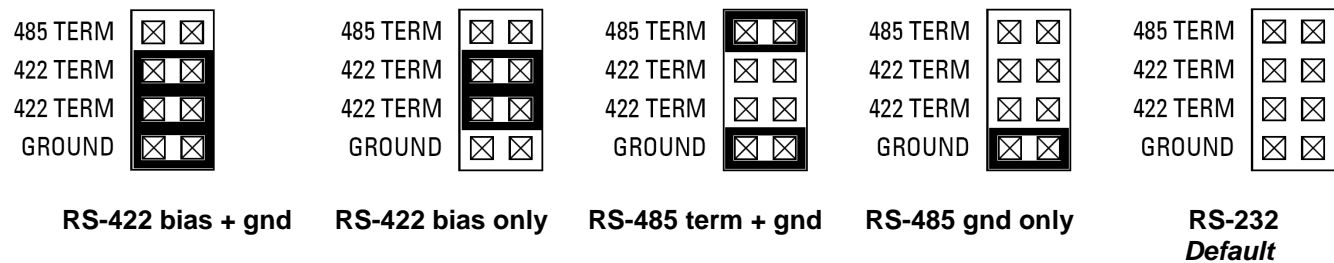

<i>Label</i>	<i>Function</i>
485 TERM	RS-485 Tx termination resistor
422 TERM	RS-422 Rx termination and bias resistors
GROUND	Second ground pin for RS-422 / RS-485

7 POWER CONSIDERATIONS

Power for the Octavio-HLV system may be provided by either a 5V supply, such as a traditional AT-style or ATX-style power supply, or by a variable voltage DC supply. In either case, the power supply interfaces to the enclosure through the 4-pin Mini-Fit type connector on the front panel, labeled “POWER IN.”

- When using a 5V input, the power input must be on pin 4.
- When using a variable voltage input, the power input must be on pin 1.

Refer to section 4.5 for further details.

7.1 Power Switch Usage

The Octavio-HLV Enclosure has a provision for an optional On/Off power switch at the bottom right hand corner of the front panel. The Octavio-HLV Enclosure is shipped with the power switch enabled. That means that the system will boot when power is applied and the power switch is turned to the *On* position. To disable the power switch, users must perform two tasks, described below. **Note:** *The tasks differ slightly depending on whether the enclosure is powered by a 5V supply or by a variable voltage DC supply.*

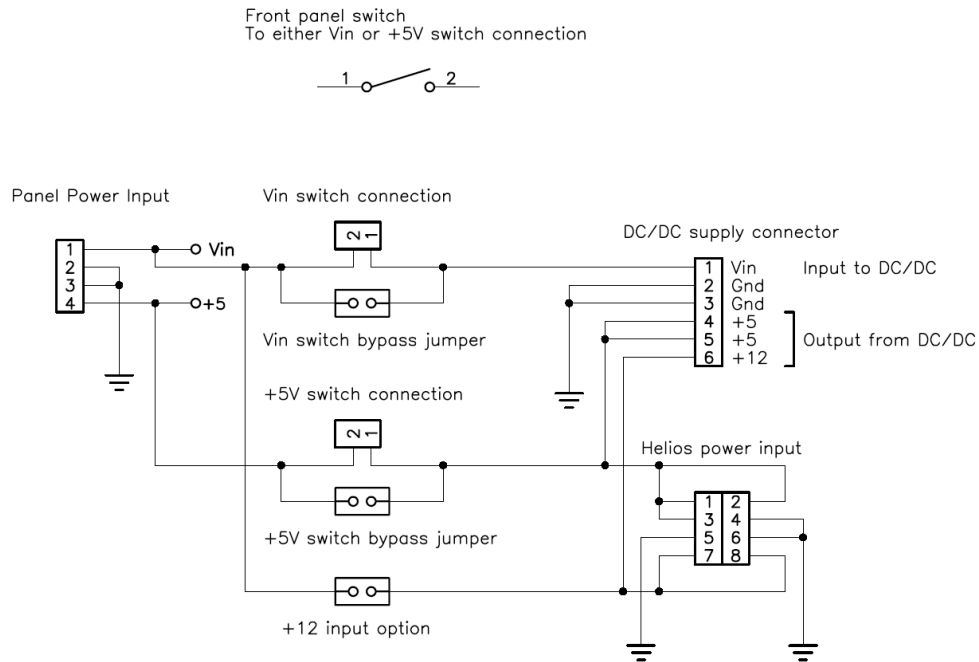

7.1.1 5V Power Input

Remove the cable from the power switch and the two-pin connector at J25.

Install a 0Ω resistor at R3. To do this, you will need to disassemble the Panel I/O Board from the Octavio-HLV Enclosure end cap.

7.1.2 Variable voltage input

1. Remove the cable between the power switch and the two-pin connector at J23.
2. Install a 0Ω resistor at R2. To do this, you will need to disassemble the Panel I/O Board from the Octavio-HLV Enclosure end cap.

Note that the power switch does not operate like the switch on an ATX-style PC. The switch controls all power to the system. No sustaining or standby voltage is supplied when the system is off. A soft-off through the operating system does not shutdown the power supply to the system.

7.2 Direct SBC Power vs. Power Via DC/DC Supply Board

The Octavio-HLV system provides two methods of powering the System:

- The Helios SBC can be powered directly, also powering the entire PC/104 stack.
- The Octavio-HLV Enclosure can power a DC/DC power supply board in the stack.

When a 5V input is used, either of these two provisions may be selected. When a variable voltage input is used, power must be routed to the DC/DC supply board.

For the direct SBC power connection, simply supply 5V through the front panel power connector. Power is supplied to the SBC directly.

To power the system through a DC/DC power supply board in the stack, you must cable from either the J34 or J35 connector to the power supply board. The connectors differ only in their interface. Choose the connector most appropriate to the power requirements of the DC/DC board and the amount of current you are supplying.

8 ADDITIONAL INTERNAL EXPANSION

The following diagrams show how the Helios SBC plus optional expansion boards might interface and cable to the Octavio-HLV's Panel I/O Board.

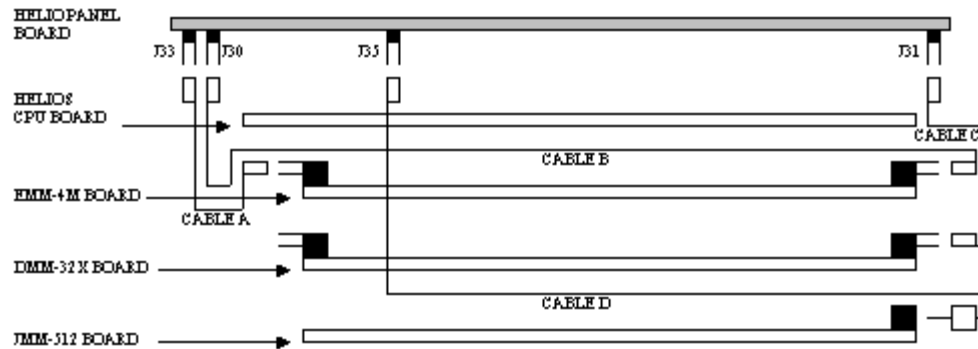

9 END CAP DIMENSIONS

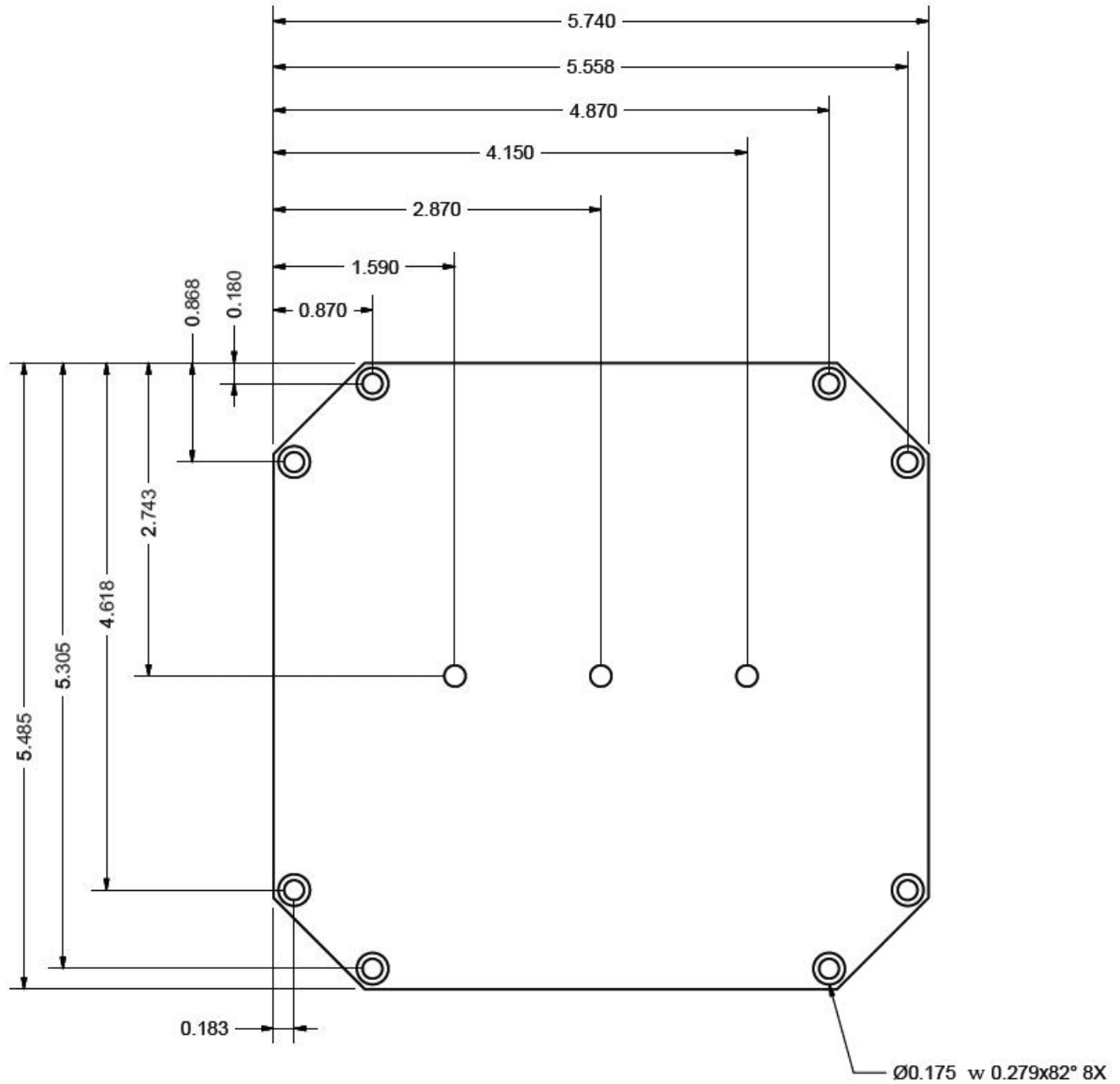

10 TECHNICAL SUPPORT

For technical support, visit the [Diamond Systems website](http://www.diamondsystems.com), email support@diamondsystems.com, or contact Diamond's technical support department at 1-800-36-PC104.